

Technical drawings are subject to change without notice.
 All millimeter dimensions are exact and supersede inch conversions.

Copyright MWE NA Inc., all rights reserved. Reproduction or other use of these designs without written consent from MWE NA Inc. is prohibited.

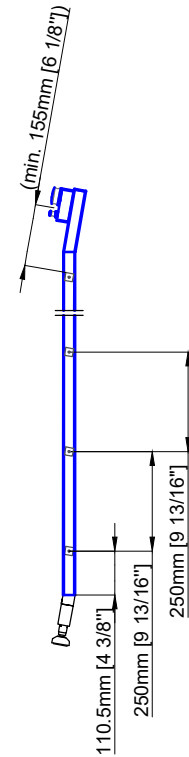

Ladder height at or above 3000mm [118 1/8"]
 require safety side rails SL.6052.AK

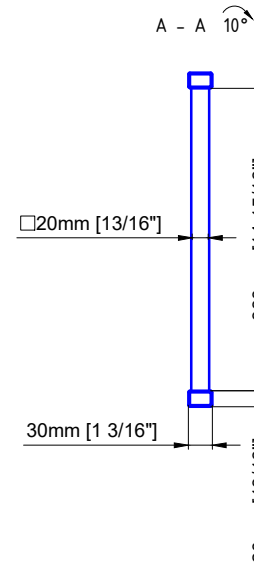
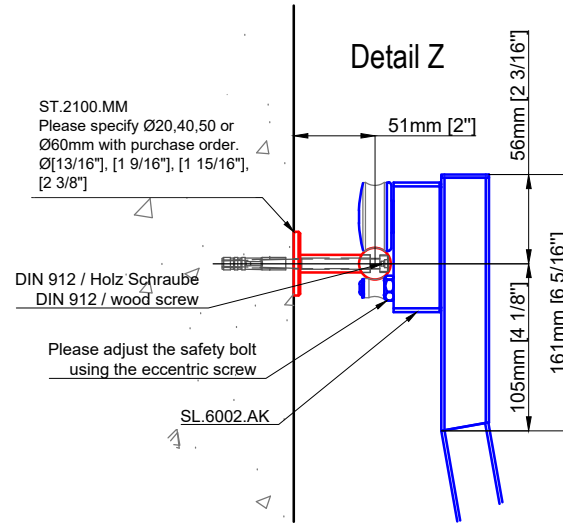
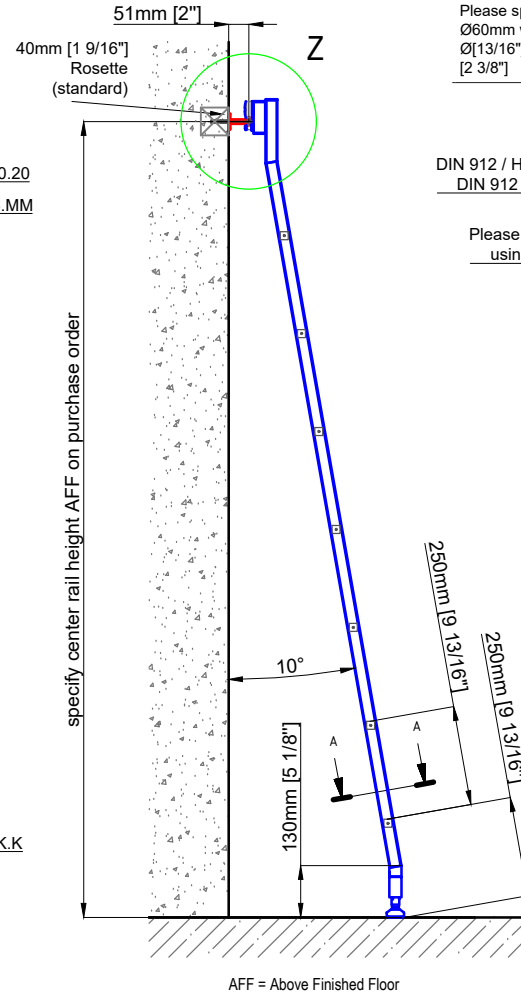
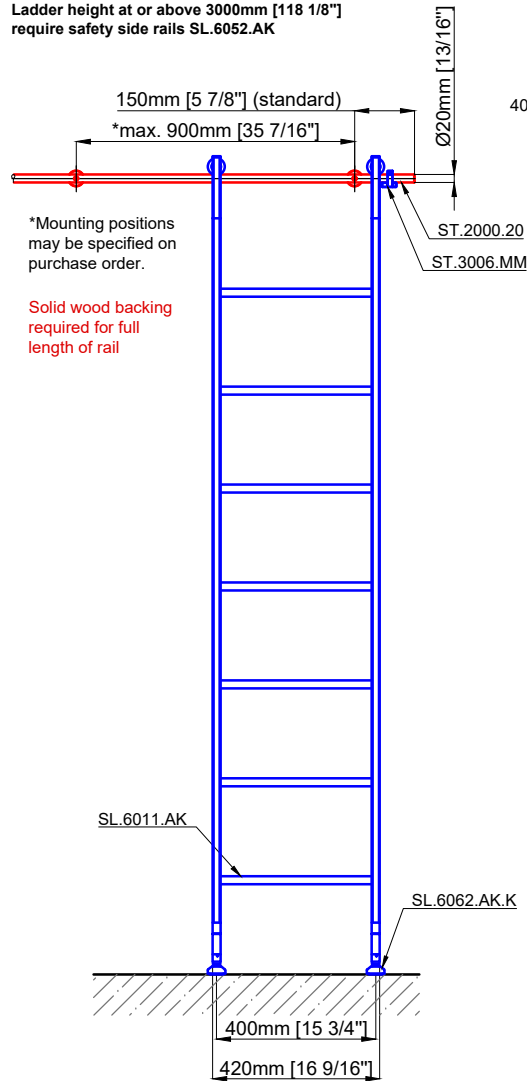

Sliding Ladder

SL.6002.AK

Date Prepared: March 2024

Prepared By: AB

Technical drawings are subject to change without notice.
 All millimeter dimensions are exact and supersede inch conversions.

Copyright MWE NA Inc., all rights reserved. Reproduction or other use of these designs without written consent from MWE NA Inc. is prohibited.

Ladder height at or above 3000mm [118 1/8"]
 require safety side rails SL.6052.AK

150mm [5 7/8"] (standard)

*max. 900mm [35 7/16"]

Ø20mm [13/16"]

*Mounting positions
 may be specified on
 purchase order.

Solid wood backing
 required for full
 length of rail

ST.2000.20
 ST.3006.MM

SL.6013.AK
 SL.6070.AK

SL.6062.AK.K

400mm [15 3/4"]
 420mm [16 9/16"]

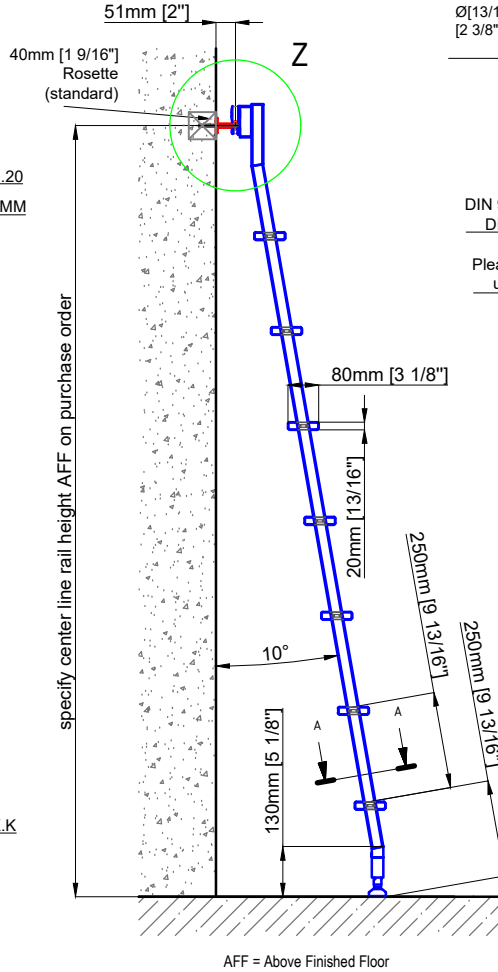

ST.2100.MM
 Please specify Ø20,40,50 or
 Ø60mm with purchase order.
 Ø[13/16"], [1 9/16"], [1 15/16"],
 [2 3/8"]

Detail Z

DIN 912 / Holz Schraube
 DIN 912 / wood screw

Please adjust the safety bolt
 using the eccentric screw

SL.6002.AK

A - A 10°

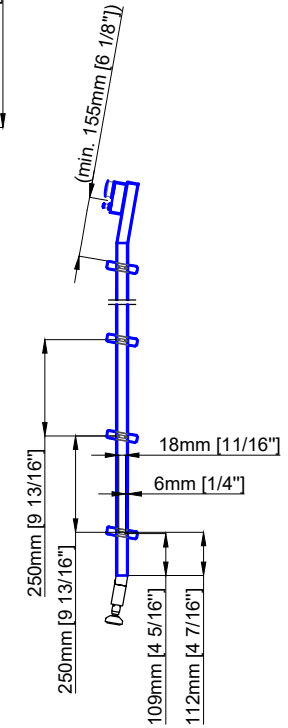
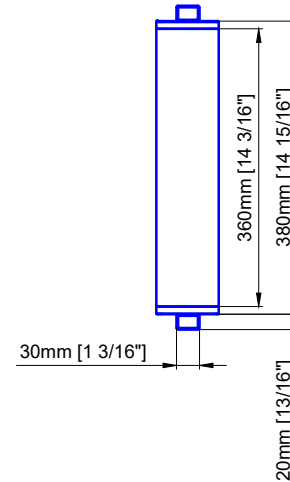

Sliding Ladder

SL.6002.AK.E

Date Prepared: March 2024

Prepared By: AB

Technical drawings are subject to change without notice.
 All millimeter dimensions are exact and supersede inch conversions.

Copyright MWE NA Inc., all rights reserved. Reproduction or other use of these designs without written consent from MWE NA Inc. is prohibited.

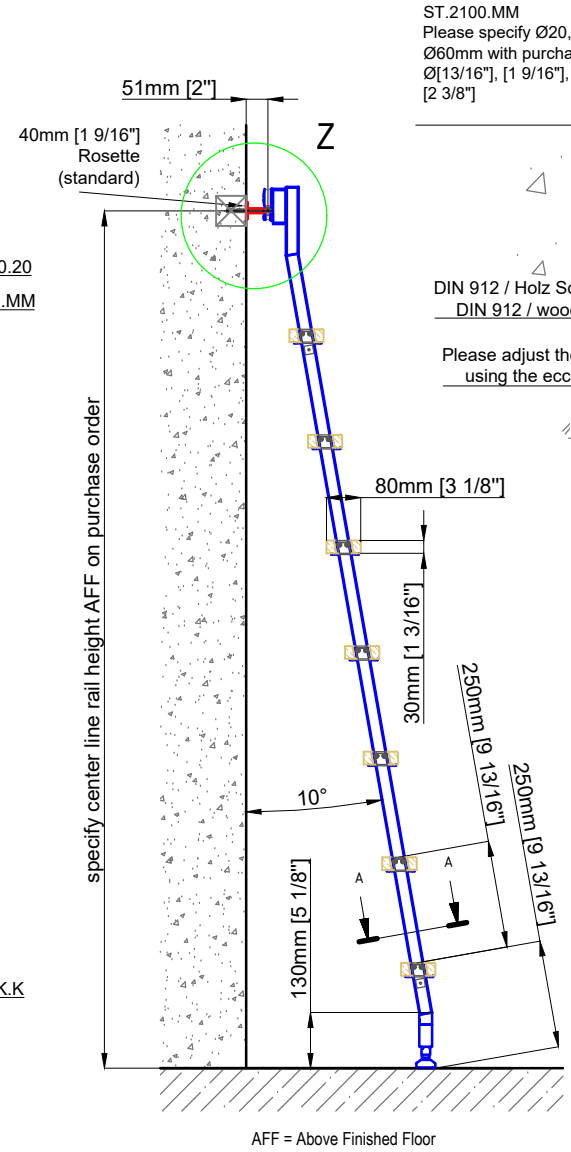
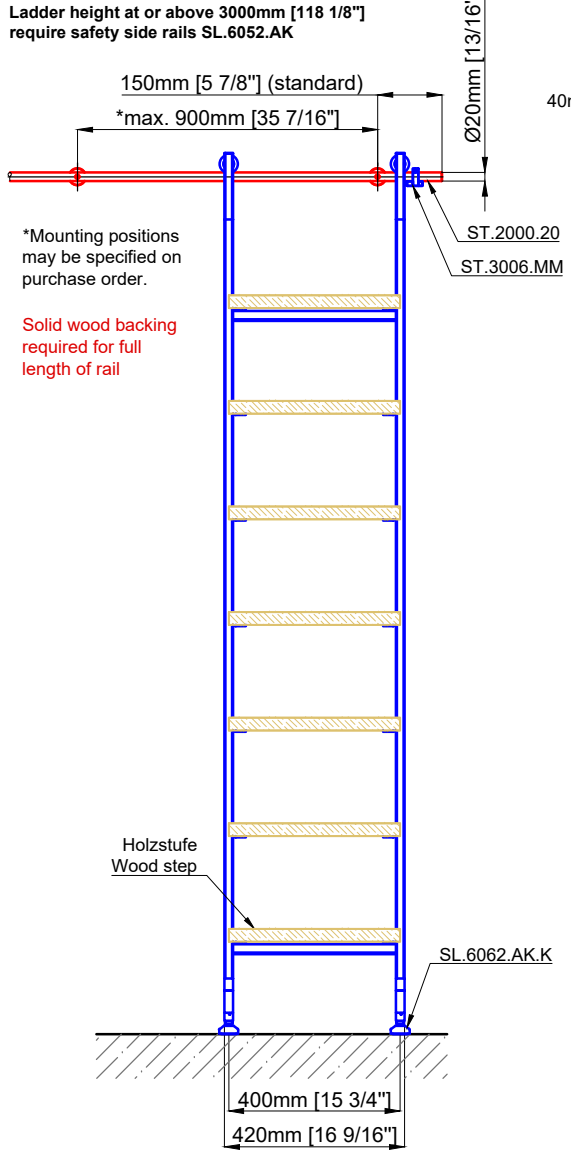

ST.2100.MM
 Please specify Ø20,40,50 or Ø60mm with purchase order.
 Ø[13/16"], [1 9/16"], [1 15/16"], [2 3/8"]

Detail Z

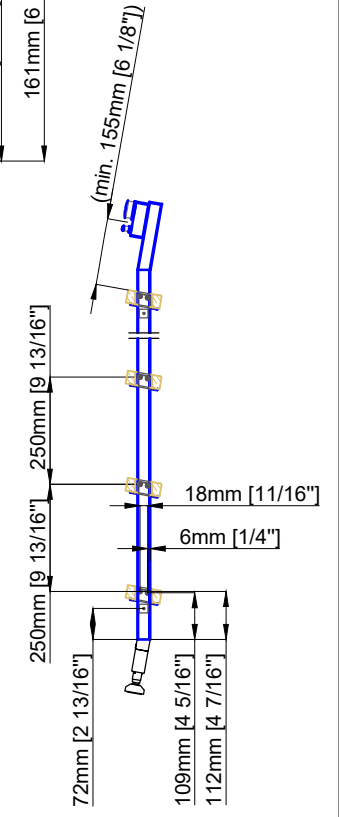
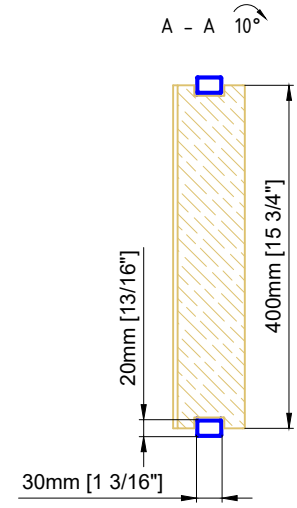
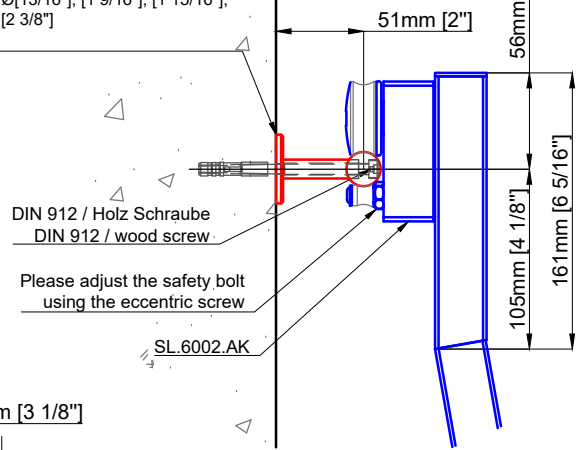

Sliding Ladder
 SL.6002.AK.H

Date Prepared: March 2024 | Prepared By: AB

Technical drawings are subject to change without notice.
 All millimeter dimensions are exact and supersede inch conversions.

Copyright MWE NA Inc., all rights reserved. Reproduction or other use of these designs without written consent from MWE NA Inc. is prohibited.

Ladder height at or above 3000mm [118 1/8"]
 require safety side rails SL.6052.AK

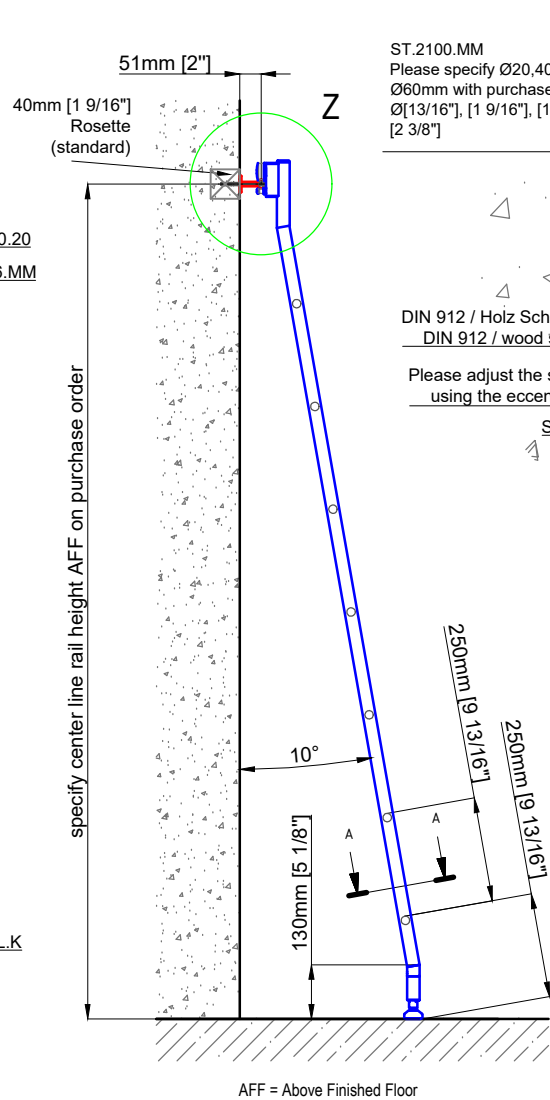
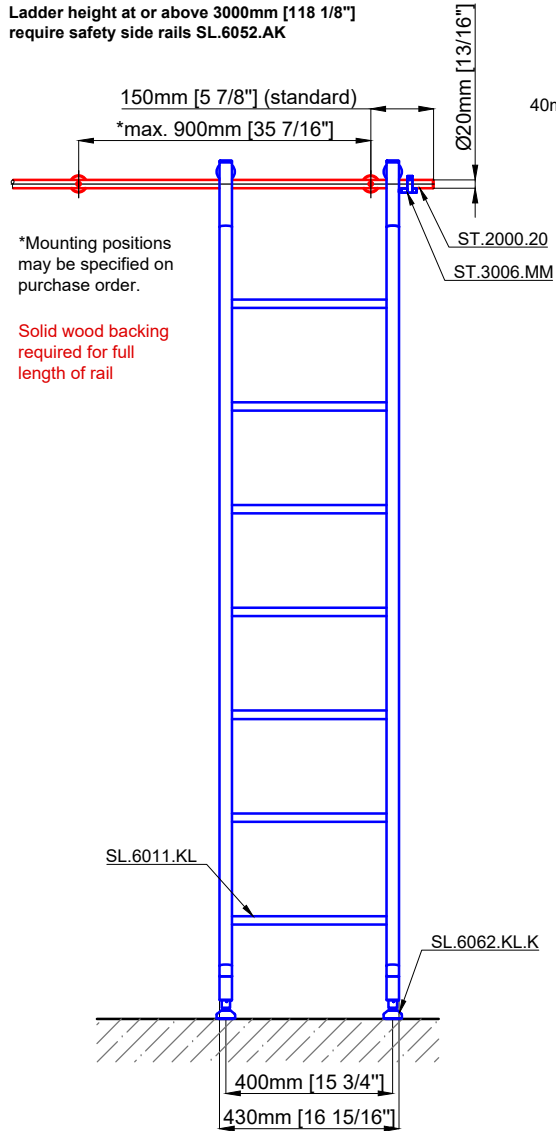

ST.2100.MM
 Please specify Ø20,40,50 or Ø60mm with purchase order.
 Ø[13/16"], [1 9/16"], [1 15/16"], [2 3/8"]

Detail Z

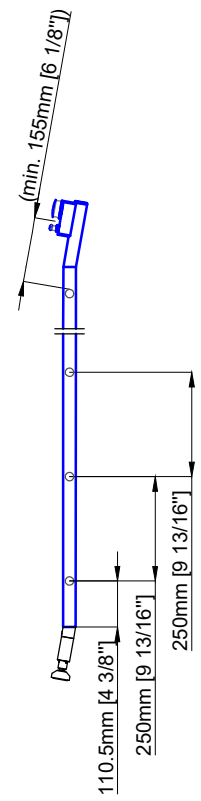
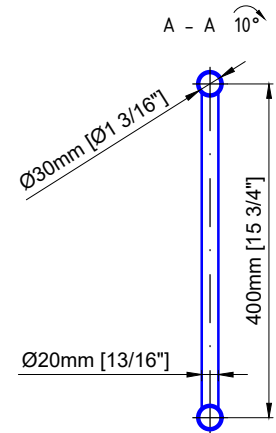
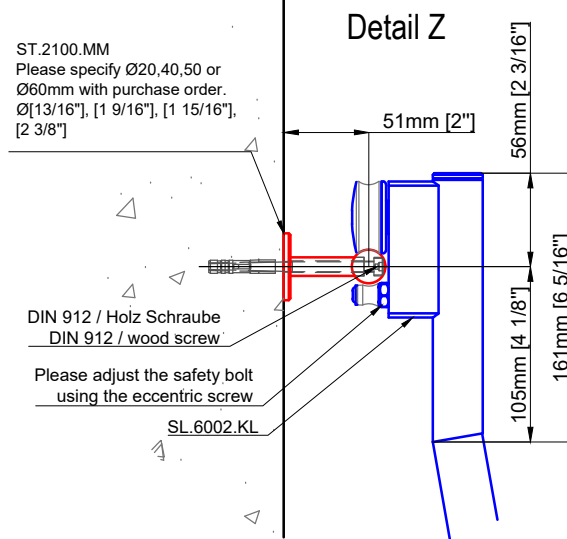

Sliding Ladder
 SL.6002.KL

Date Prepared: March 2024

Prepared By: AB

Technical drawings are subject to change without notice.
 All millimeter dimensions are exact and supersede inch conversions.

Copyright MWE NA Inc., all rights reserved. Reproduction or other use of these designs without written consent from MWE NA Inc. is prohibited.



Ladder height at or above 3000mm [118 1/8"] require safety side rails SL.6052.AK

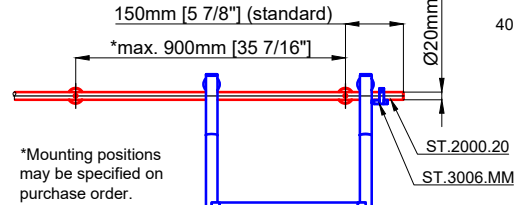

*Mounting positions may be specified on purchase order.

Solid wood backing required for full length of rail

SL.6013.KL
 SL.6070.KL

SL.6062.KL.K

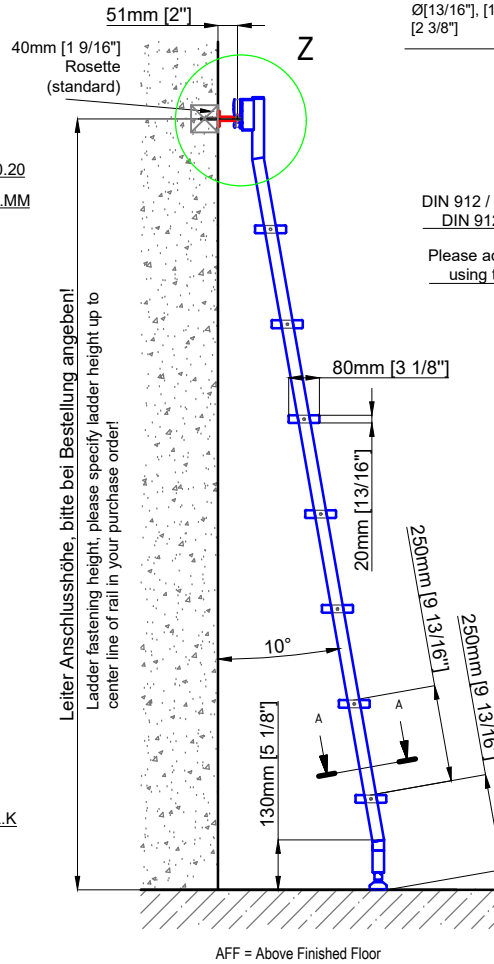
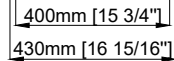

Leiter Anschlusshöhe, bitte bei Bestellung angeben!
 Ladder fastening height, please specify ladder height up to center line of rail in your purchase order!

ST.2100.MM
 Please specify Ø20,40,50 or Ø60mm with purchase order.
 Ø[13/16"], [1 9/16"], [1 15/16"], [2 3/8"]

Detail Z

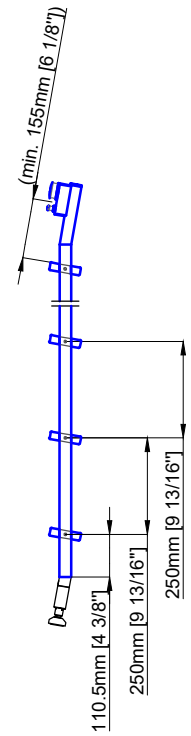
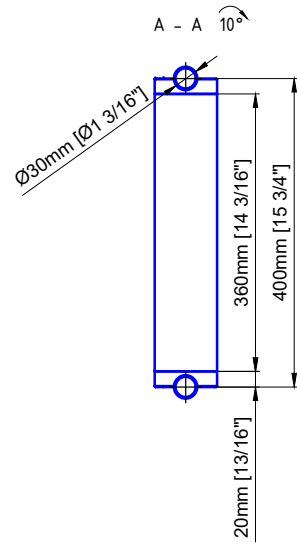
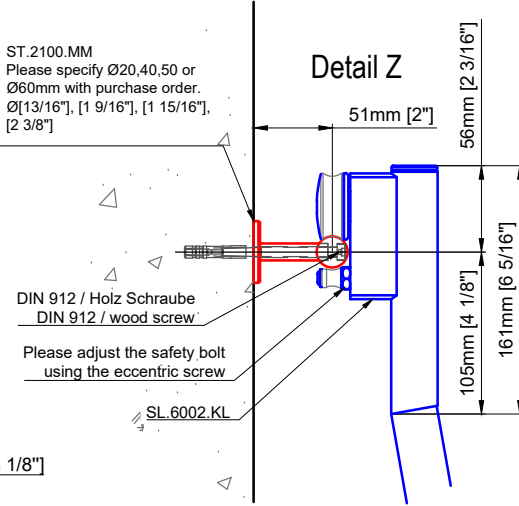

Sliding Ladder

SL.6002.KL.E

Date Prepared: March 2024

Prepared By: AB



1901 Tigertail Blvd. Dania Beach FL 33004
 954.924.6137 | www.BartelsDoors.com

Technical drawings are subject to change without notice.
 All millimeter dimensions are exact and supersede inch conversions.

Copyright MWE NA Inc., all rights reserved. Reproduction or other use of these designs without written consent from MWE NA Inc. is prohibited.

Ladder height at or above 3000mm [118 1/8"]
 require safety side rails SL.6052.AK

150mm [5 7/8"] (standard)
 *max. 900mm [35 7/16"]

*Mounting positions
 may be specified on
 purchase order.

Solid wood backing
 required for full
 length of rail

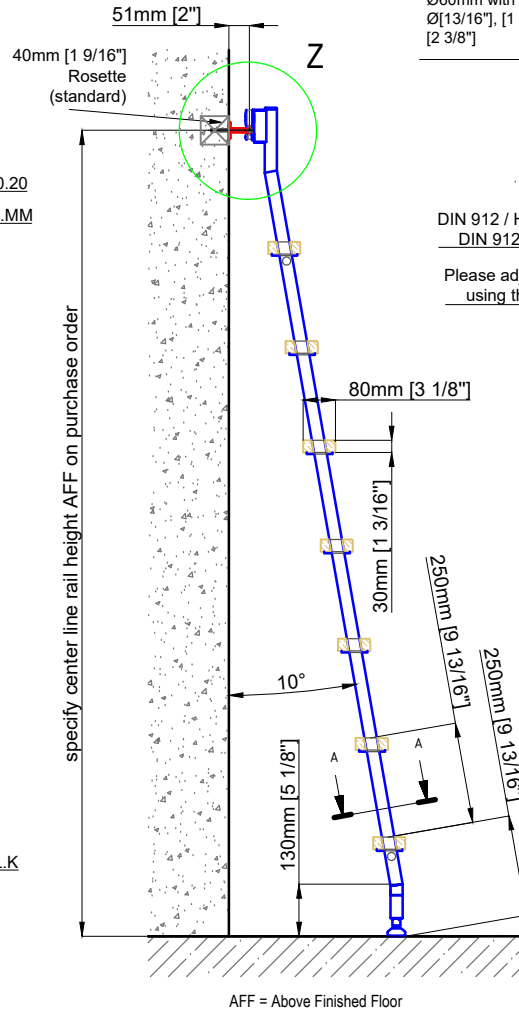
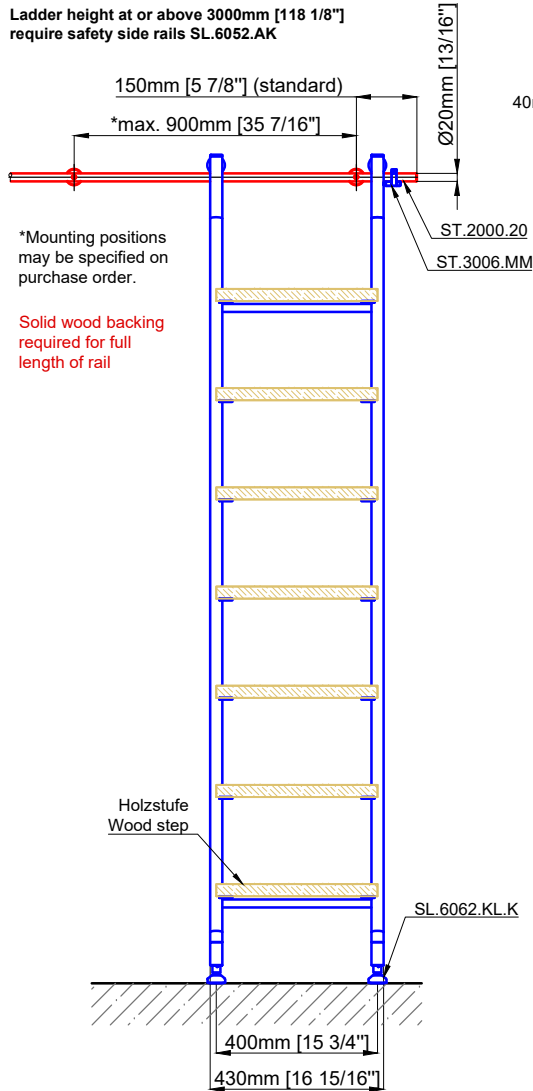

ST.2100.MM
 Please specify $\varnothing 20, 40, 50$ or
 $\varnothing 60\text{mm}$ with purchase order.
 \varnothing [13/16"], [1 9/16"], [1 15/16"],
 [2 3/8"]

Detail Z

DIN 912 / Holz Schraube
 DIN 912 / wood screw

Please adjust the safety bolt
 using the eccentric screw

SL.6002.KL

A - A 10°

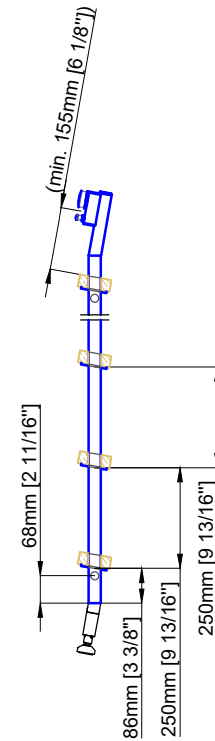
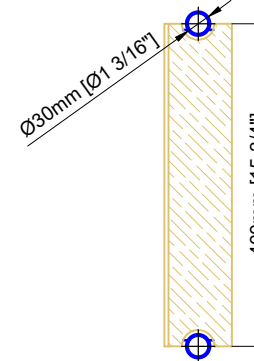

Sliding Ladder

SL.6002.KL.H

Date Prepared: March 2024

Prepared By: AB