

BARTELS Smart Track
Pocket Door Hardware



Features

- Optional recessed hardware
- Tracks available for up to 176 lbs. & 264 lbs. panel weight
- Soft Stop
- Push-to-Open Function
- Easy door installation and adjustment after track/wall install

Advantages

- Adjustment after wall completion
- Wooden door can be mounted under the top track
- Minimal friction - Quite glide
- Easy and quick height adjustment (on the front)
- Exchange components without opening the finished wall

Uses

- Wood
- Glass

Product Description
BARTELS Smart Track

Track for Glass up to 176 lbs.

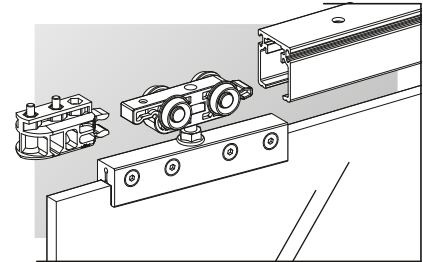

Stopper and track - two pieces per door. The wheel clamp is mounted to the door leaf, the stopper to the track. The door can be removed and attached while the track remains installed.

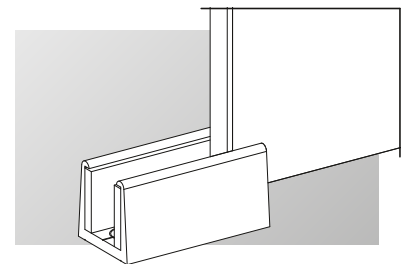

Floor guide - for glass doors, screws into the floor.

- For wall or ceiling mounting
- Aluminum or stainless steel look
- Track allows for adjustment
- Lengths available up to 2000 & 3000 mm (78-3/4" & 118")
- A separate top track is required for each door
- Up to 176 lbs.
- Suitable for 3/8" glass
- Optional soft stop on one side with push-to-close feature or soft close on both sides

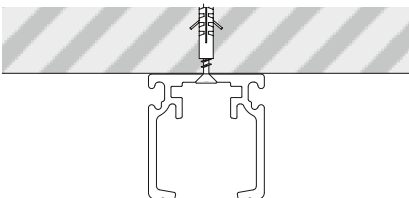

Track for ceiling mounting includes access opening for adjustment

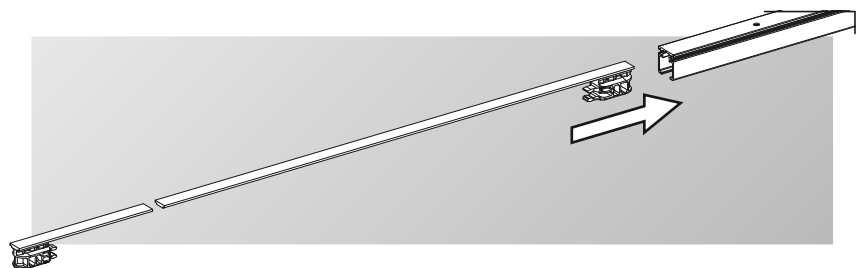

Adjustment lever for easy adjustment or replacement of stoppers when installed. The finished wall does not need to be opened.

Track for Wood up to 176 lbs.

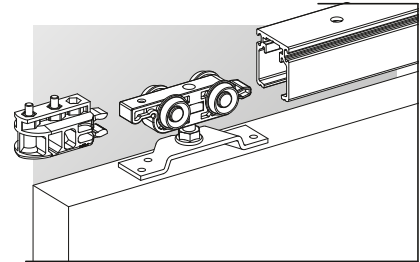

Stopper and track - two pieces per door. The wheel bracket is mounted to the door leaf, the stopper to the track. The door can be removed and attached while the track remains installed.

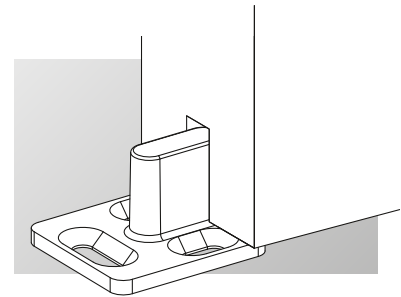

Floor guide - for wood doors, screws into the floor

- For wall or ceiling mounting
- Aluminum or stainless steel look
- Track allows for adjustment opening
- Lengths available up to 2000 & 3000 mm (78-3/4" & 118")
- A separate top track is required for each door
- Up to 176 lbs.
- Up to 1-9/16" thick door
- At least 27" wide door leaf
- Optional soft stop on one side with push-to-close feature or soft close on both sides

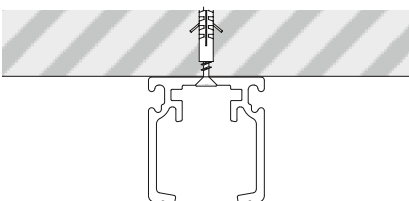

Track for ceiling mounting includes access opening for adjustment

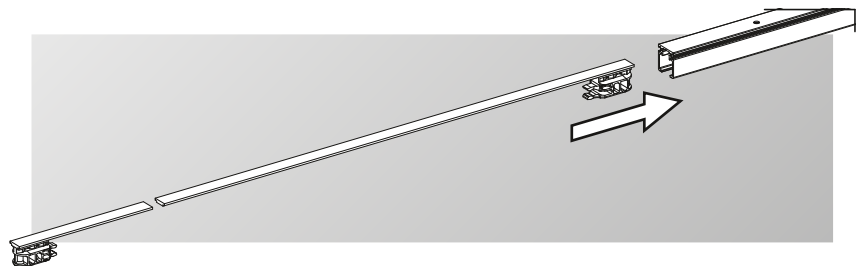

Adjustment lever for easy adjustment or replacement of stoppers when installed. The finished wall does not need to be opened.

Product Description

BARTELS Smart Track

Valance profile for glass doors

- Mounts to top track
- On-site finishing not required
- Aluminum or stainless steel look

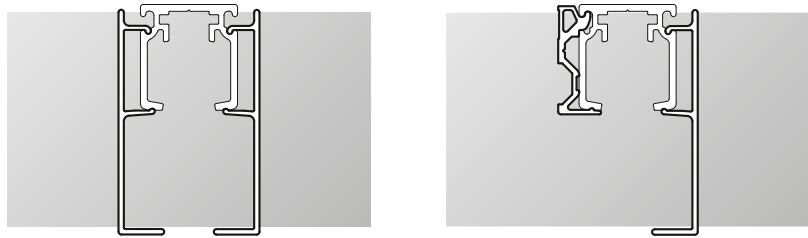

Valance profile - double sided mounting for ceiling mounted systems,
single side mounting for wall mounted systems

Valance profile for wood doors

- Mounts to top track
- On-site finishing not required
- Aluminum or stainless steel look



Valance profile - double sided mounting for ceiling mounted systems,
single side mounting for wall mounted systems

End cap for glass doors

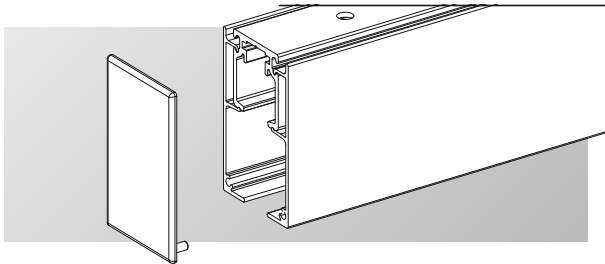

- To be inserted into the track
- Made of plastic

End cap for wood doors

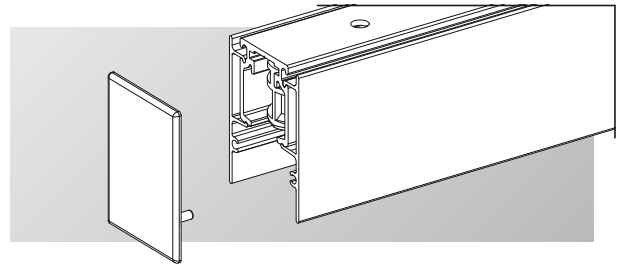

- To be inserted into the track
- Made of plastic

Synchronization for wood doors



- Both doors can open and close simultaneously using a cable
- For two wood doors up to 176 lbs. per door leaf
- Comfortable operation with one hand

Product Description

BARTELS Smart Track

Recessed Door Install

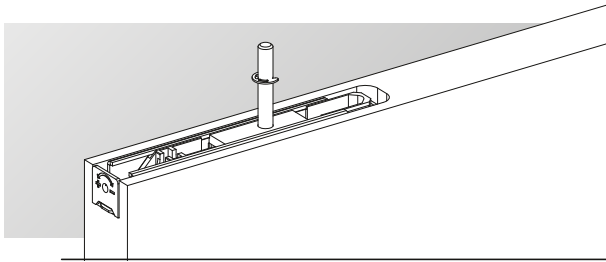

Door System with Panels

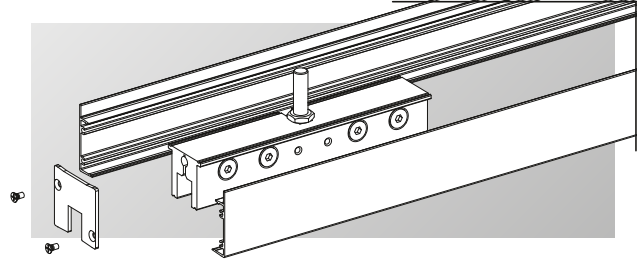

- All BARTELS Smart Track systems are available a recessed mounting option - embedded in top of the door leaf
- No valance required
- Up to 176 lbs. door leaf

Soft Stop

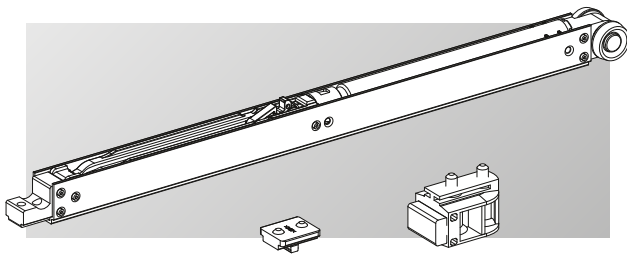

- For gentle door closing
- Locking the doors
- Maximum weight of 176 lbs.
- Minimum door width of 27" when used on one side
- Minimum door width of 41" when used on both sides

Push to close

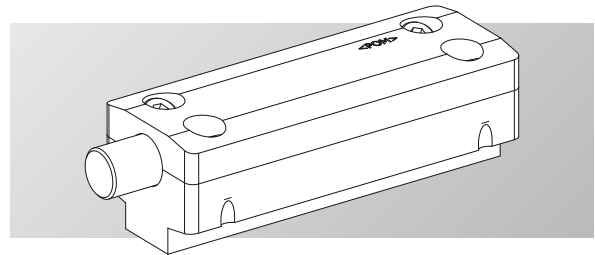

- For pocket door assembly
- Maximum weight of 176 lbs.
- Mounting on the side of the track
- Can be combined with one-sided soft close on the opposite side

Locking Floor Guide

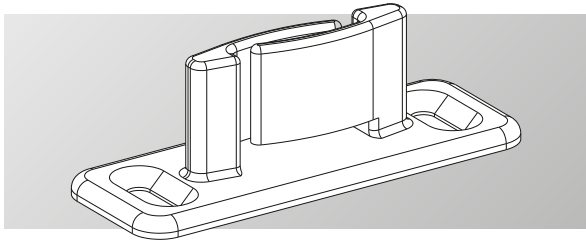

Grove Profile for Wood Doors

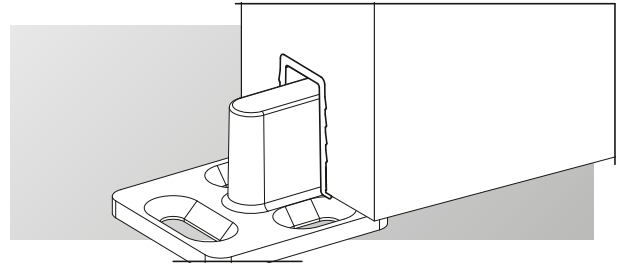

For Wood Doors Only

Product Information
BARTELS Smart Track

Sliding Door Hardware for Glass Doors

View

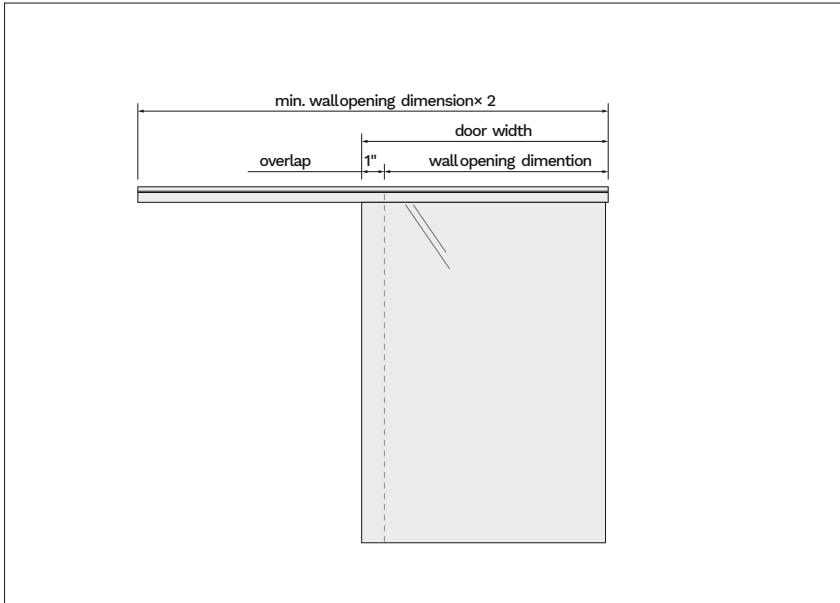

Formulas

- **Door Width** = wall opening dimension + 1"
- **Length of Track** = min. wall opening dimension x 2 + 3-15/16"
(A 1" overlap is recommended)
- **Door Thickness:** 3/8"
- **Door Height** = Track - 2-3/4"

Wall Mounting

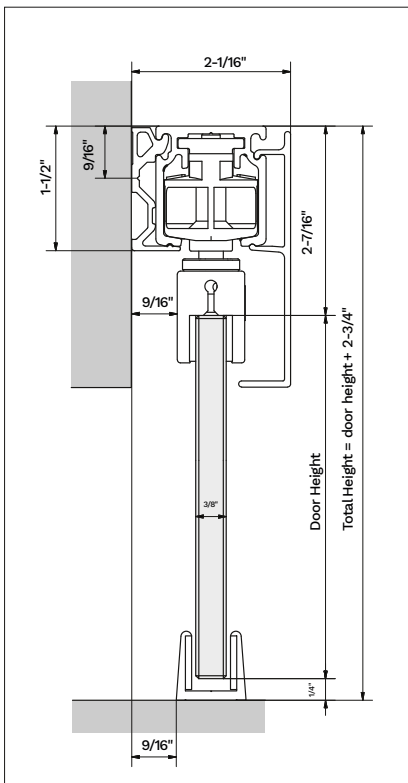

Ceiling Mounting

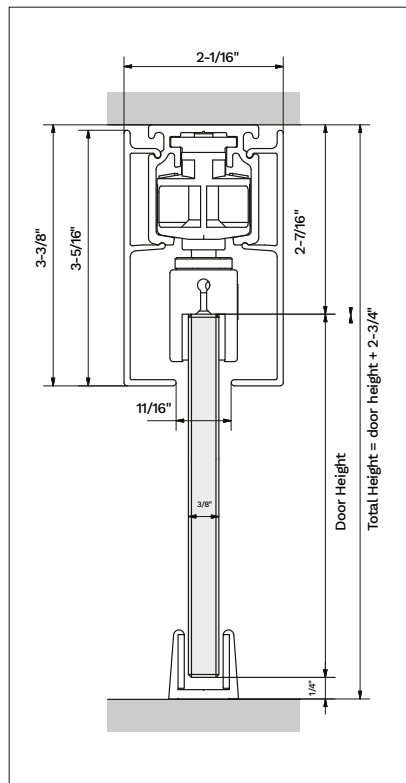

Pocket Assembly

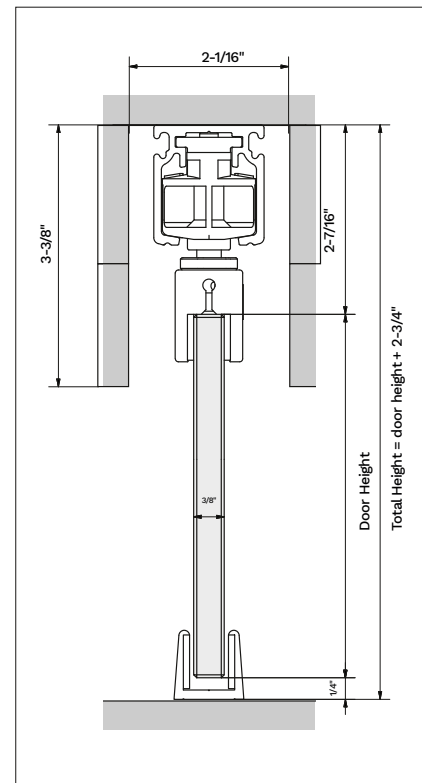

Sliding Door Hardware for Glass Doors - with clamp

View

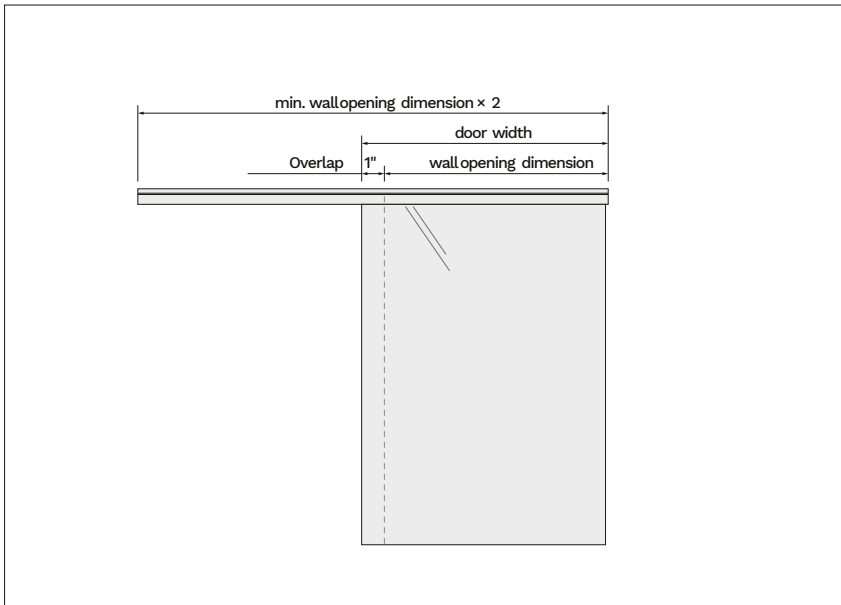

Formulas

- **Door Width** = wall opening dimension + 1"
- **Length of Track** =
min. wall opening dimension \times 2 + 3-15/16"
(A 1" overlap is recommended)
- **Door Thickness**: 3/8"
- **Door Height** = Track - 2-3/4"

Pocket Assembly

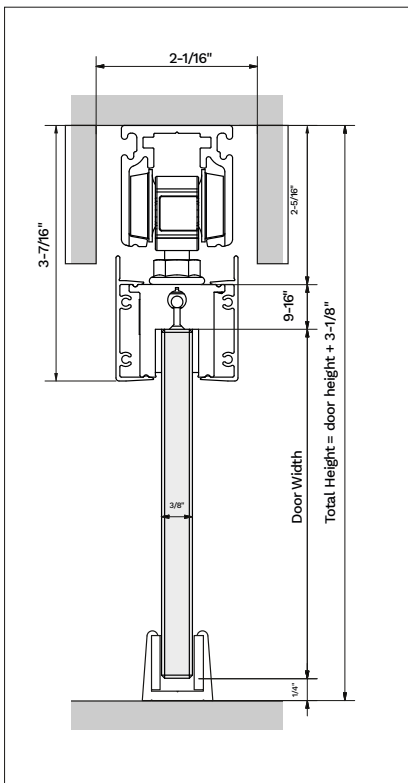

Product Information
BARTELS Smart Track

Sliding Door Hardware for Wood Doors

View

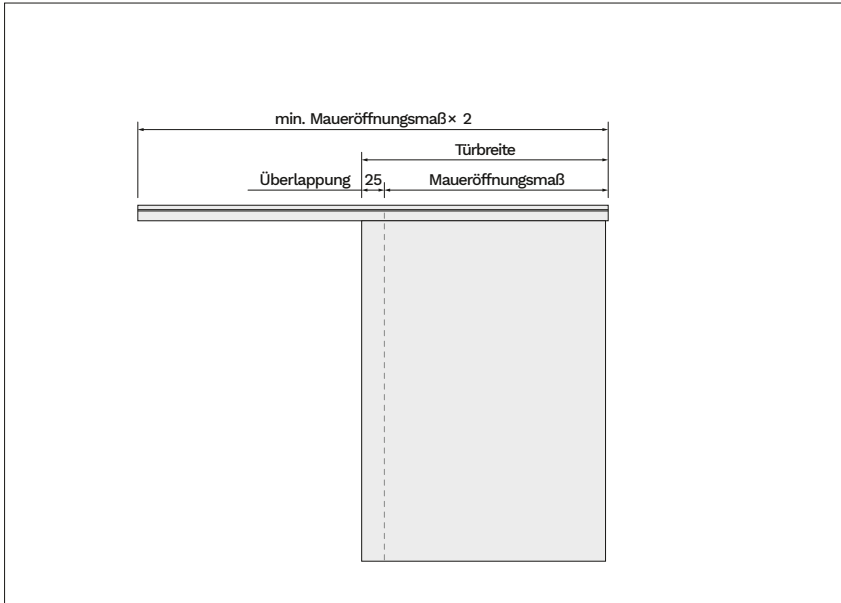

Formulas

- **Door Width** = wall opening dimension + 1"
- **Length of Track** = min. wall opening dimension x 2 + 3-15/16"
(A 1" overlap is recommended)
- **Door Thickness:** 1-9/16"
- **Door Height** = Track - 2-7/8"

Wall Mounting

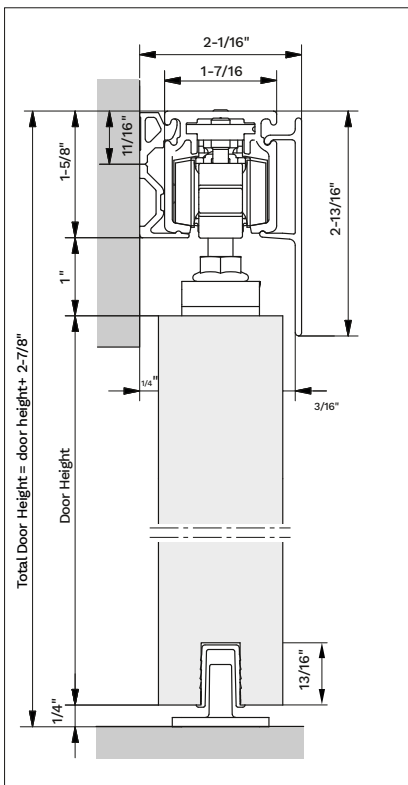

Ceiling Mounting

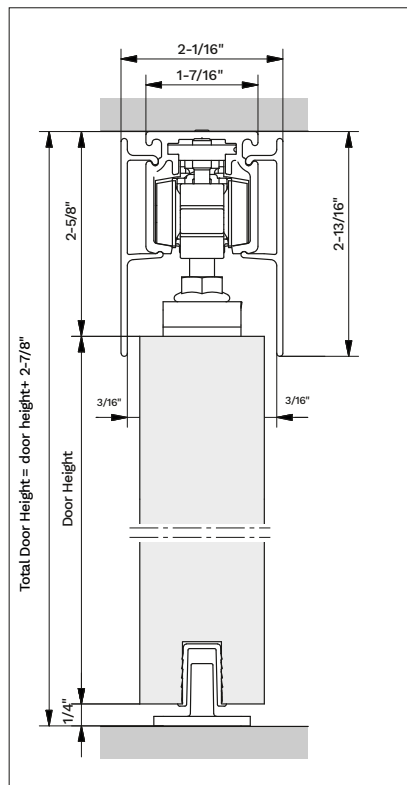

Pocket Assembly

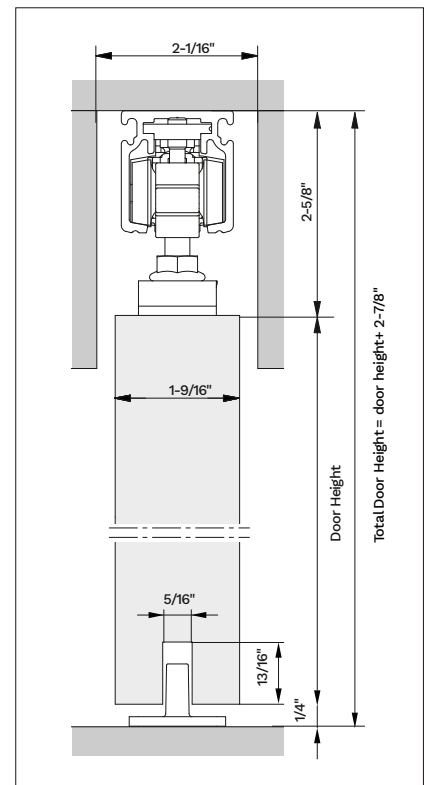

Sliding Door Hardware for Wood Doors with Recessed Mounting

View

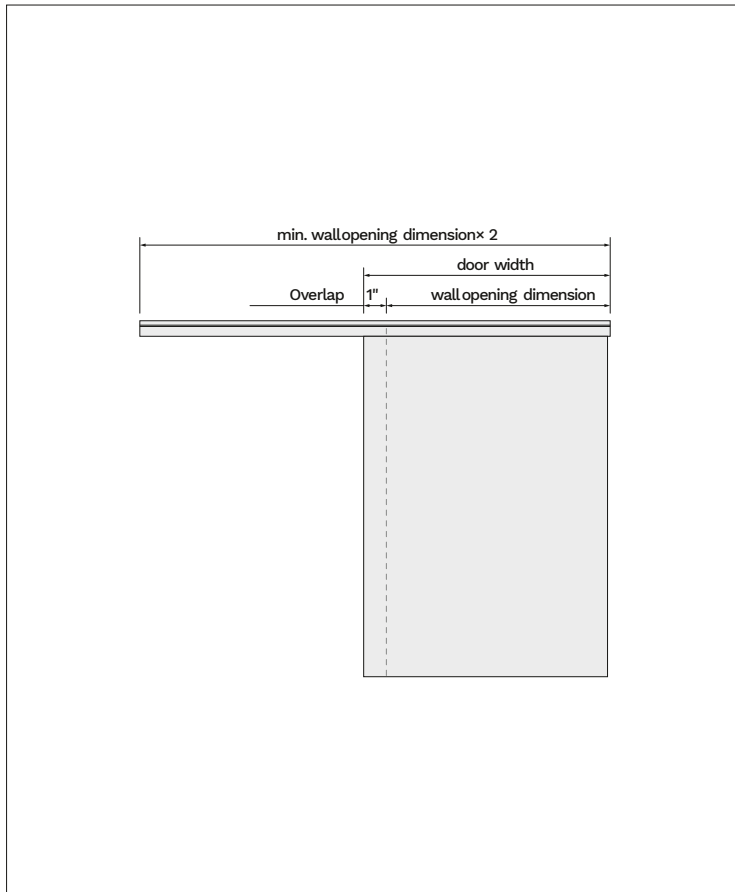

- **Door Width** = wall opening dimension + 1"
- **Length of Rail** = min. wall opening dimension x 2 + 3-15/16"
(1" overlap is recommended)

Vertical View

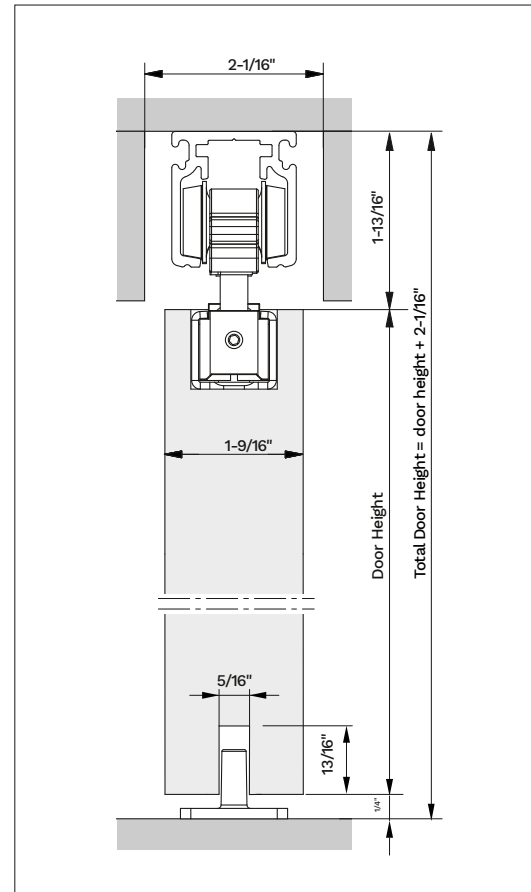

- **Door Thickness:** 1-9/16"
- **Door Height:** = track - 2-1/16"