

BARTELS Box Track
Sliding Door Hardware

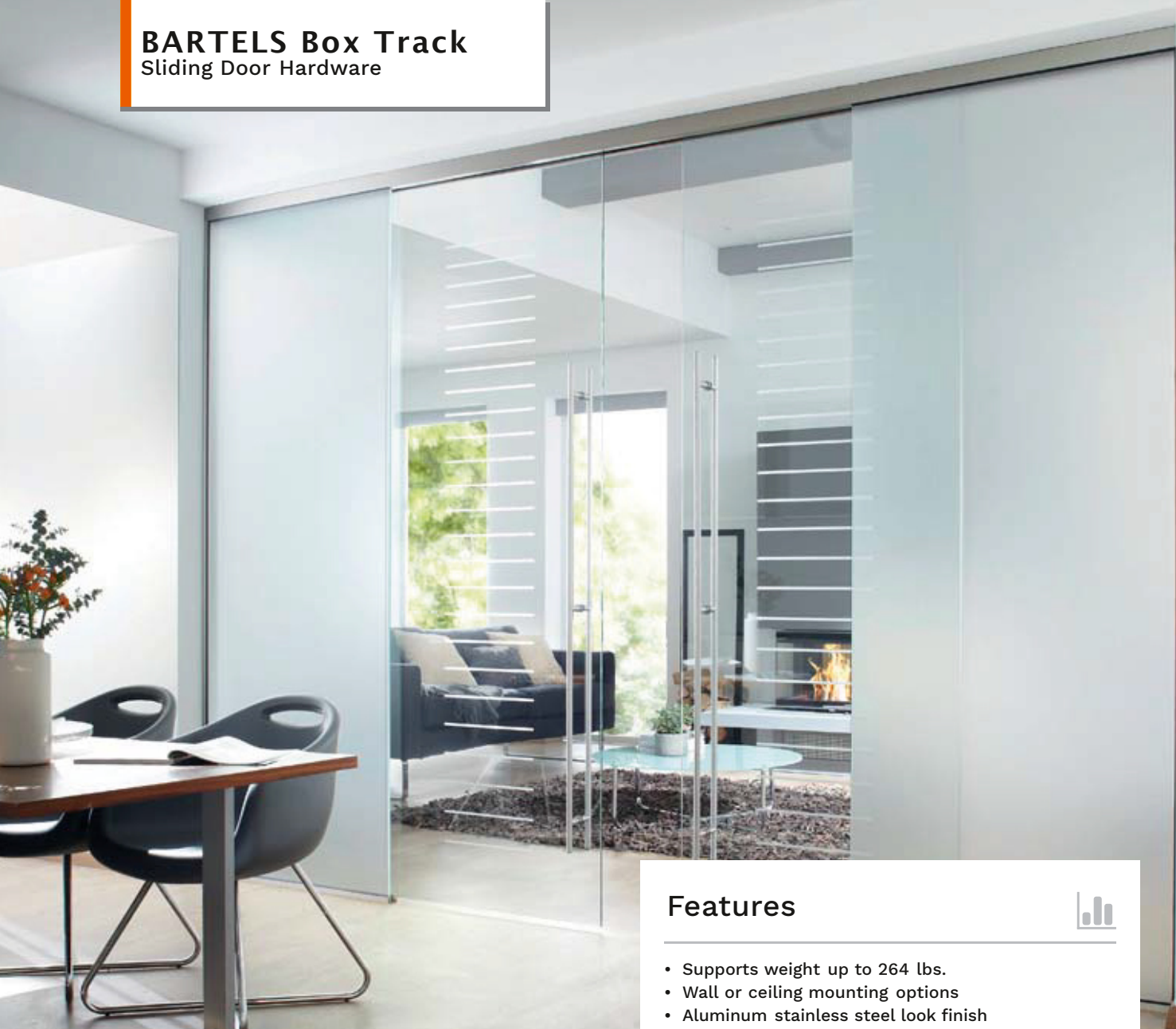

Features



- Supports weight up to 264 lbs.
- Wall or ceiling mounting options
- Aluminum stainless steel look finish

Advantages



- Easily adaptable to your design needs
- Easy installation
- Can be assembled from the front

Uses



- Wood
- Glass

Product Description
BARTELS Box Track

Track for Glass up to 264 lbs.

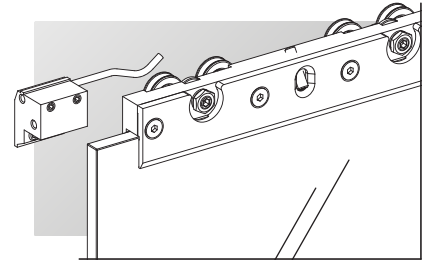

Stopper and track - two (2) pieces per door

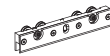

Up to 264 lb. door weight,
minimum door width: 25-9/16"



Up to 143 lb. door weight,
minimum door width: 21-5/8"



Up to 110 lb. door weight,
minimum door width: 19-11/16"

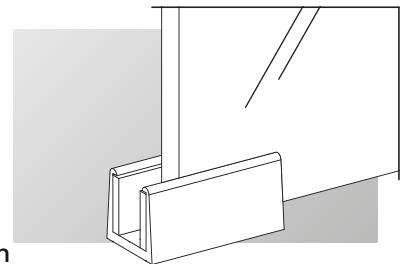

Floor guide - for glass doors,
screws into the floor.

- Wall or ceiling mounting
- Aluminum stainless steel look

- Up to 236-1/4" track length
- for 3/8" glass

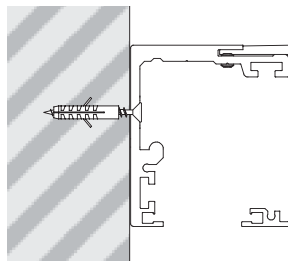
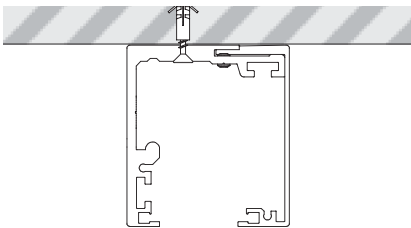

Tracks - either pre-drilled and lowered for ceiling or wall mounting

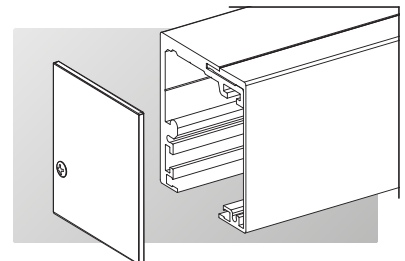

End Caps - aluminum stainless steel look - insert into the track

Track for Wood up to 264 lbs.



- Wall or ceiling mounting
- Aluminum stainless steel look

- Up to 236-1/4" track length
- for 1-3/8" wood

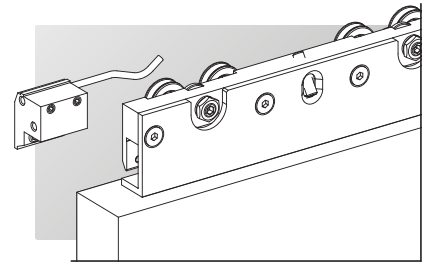

Stopper and track - two (2) pieces per door

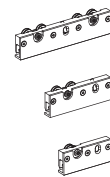

- Up to 264 lb. door weight, minimum door width: 25-9/16"
- Up to 143 lb. door weight, minimum door width: 21-5/8"
- Up to 110 lb. door weight, minimum door width: 19-11/16"

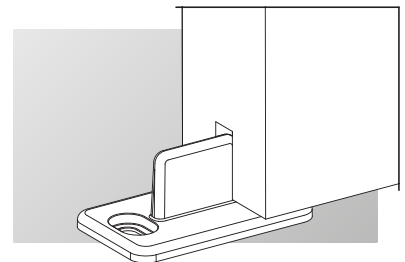

Floor guide - for wood doors, screws into the floor.

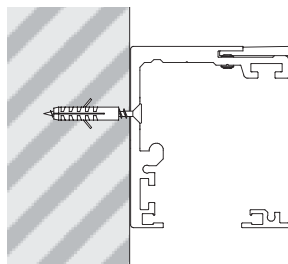
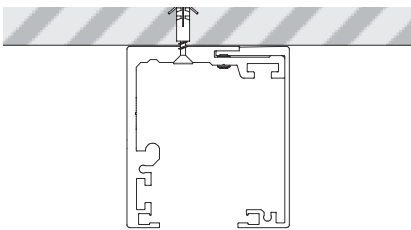

Tracks - either pre-drilled and lowered for ceiling or wall mounting

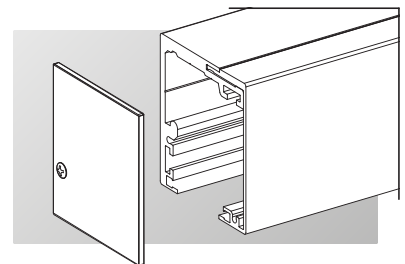

End Caps - aluminum stainless steel look - insert into the track

Product Description

BARTELS Box Track

Distance Profiles

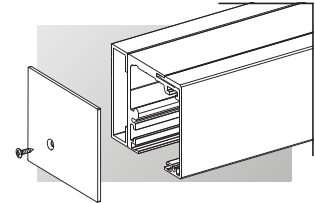
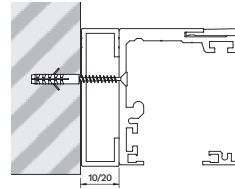

For a distance between the wall and sliding door system, for example to clear baseboards. There are end caps available in aluminum for all combinations of track and spacing profiles of different strengths.

Aluminum or Stainless Steel Look

- Length up to 236-1/4"
- Thickness up to 3/8" or 13/16"

Glued to the track

Product Description

BARTELS Box Track

Synchronization

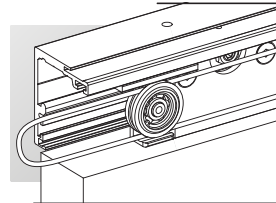

Cable system for glass doors

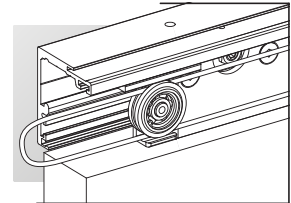

Cable system for wood doors

- For two (2) doors up to 88 lbs. per door leaf
- Both doors open/close simultaneously
- Comfortable operation with only one hand
- Cannot be combined with retraction

Soft Stop - Wood

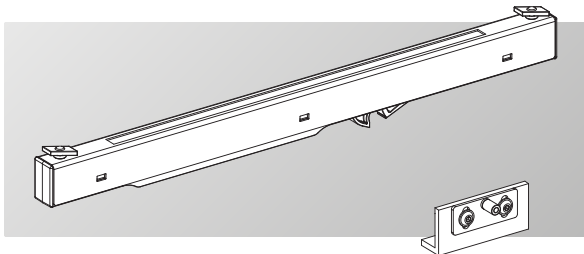

Soft Stop - Glass

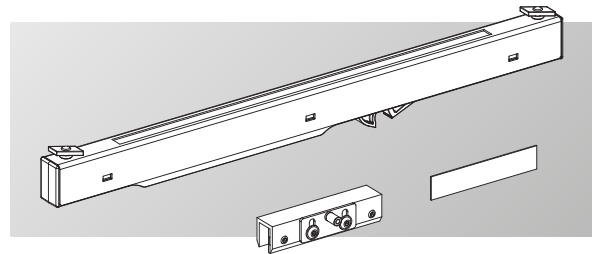

- For a gentle door stop
- Wood and glass doors
- Maximum door weight of 176 lbs

Inserted Brush Seal

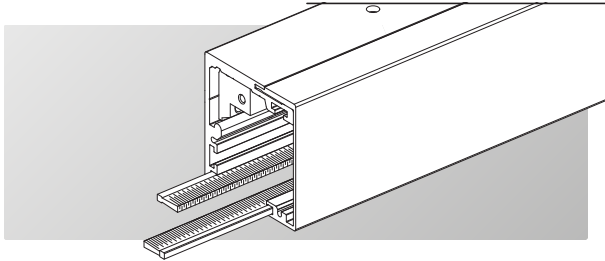

- Brush seal to be inserted into the track
- Black, tightly standing plastic bristles
- Provided in pairs
- For covering the opening

Inserted End Cap

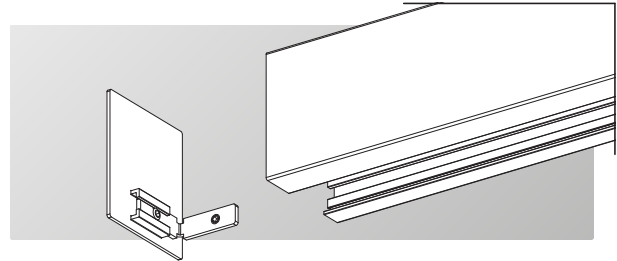

- To be inserted into the track
- No visible screw connection
- Aluminum stainless steel look

Product Description
BARTELS Box Track

Sliding Set for Glass Doors

All parts at a glance

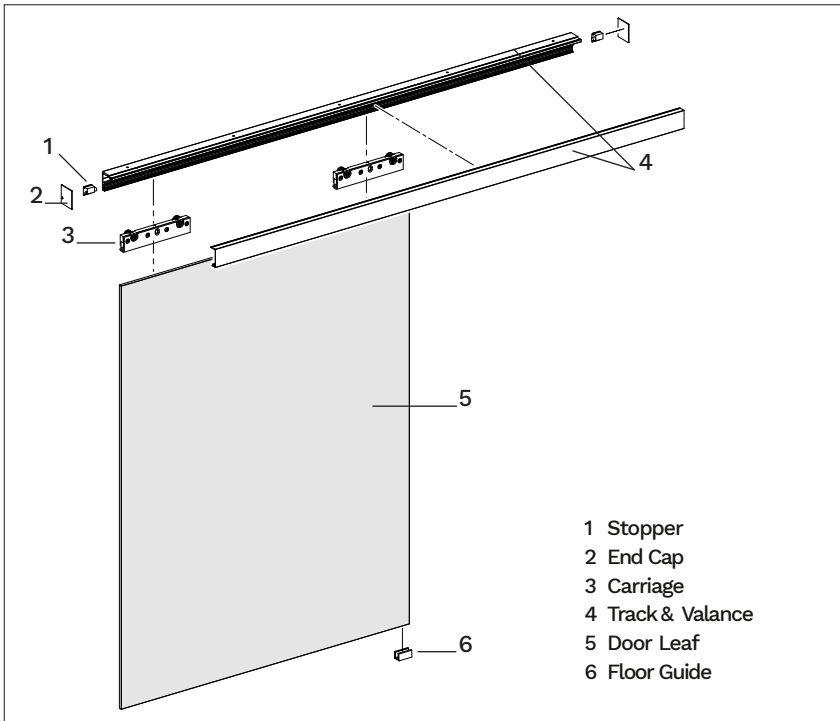

- 1 Stopper
- 2 End Cap
- 3 Carriage
- 4 Track & Valance
- 5 Door Leaf
- 6 Floor Guide

Vertical section

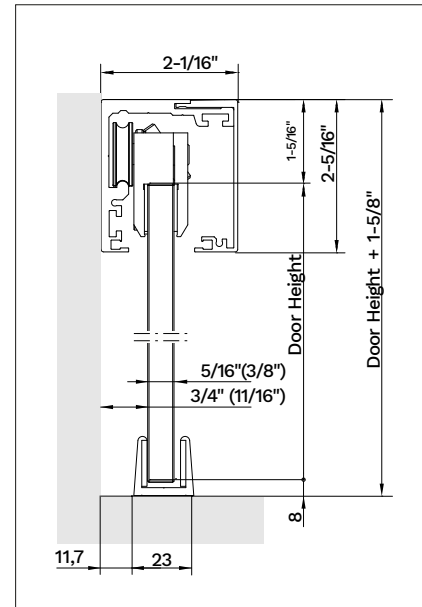

• **Door Height** = Floor to top of track-1-5/8"

Vertical section with decorative panel

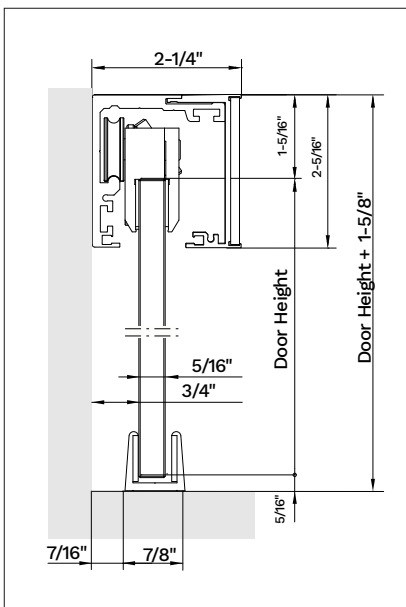

Vertical section with integrated ceiling rail

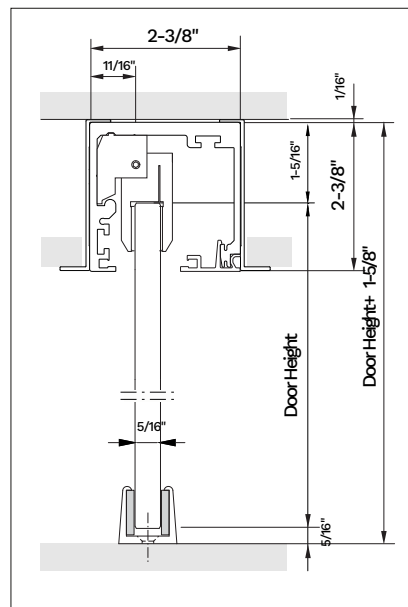

Product Description

BARTELS Box Track

Sliding Set for Glass Doors

Calculation of Door Widths

(Please note the minimum widths according to the product description - 1" overlap is recommended)

One-Panel

- **DoorWidth** = Wallopingdimension+1-15/16"
- **TrackLength** = min. walloping dimension x2

Front View (Scheme)

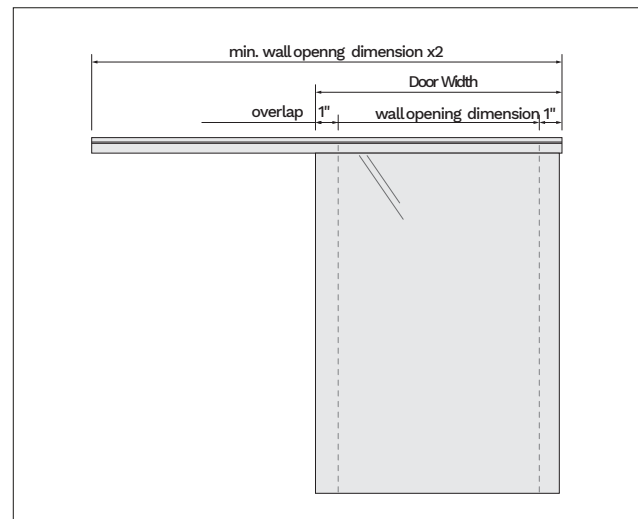

Two-Panel

- **Door Width** = Wallopingdimension/2+1"perpanel
- **Length of the running rail** = min. walloping dimensionx4

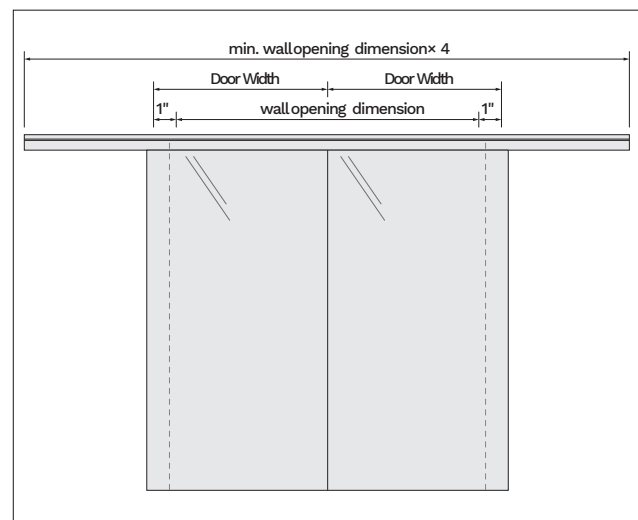

Product Description
BARTELS Box Track

Sliding Set for Wood Doors

All parts at a glance

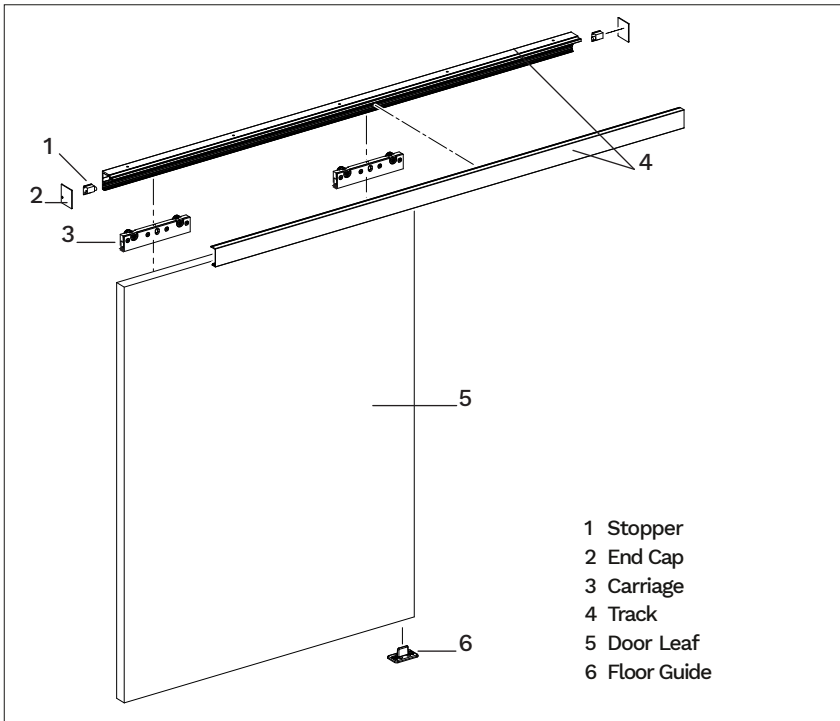

- 1 Stopper
- 2 End Cap
- 3 Carriage
- 4 Track
- 5 Door Leaf
- 6 Floor Guide

Vertical section

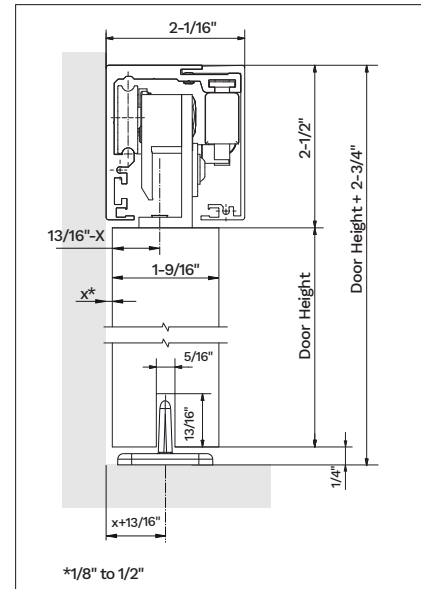

- **Door Height** = Floor to top of track–2-3/4"
- **Groove for floorguide**= 5/16"× 13/16"

Vertical section with decorative panel

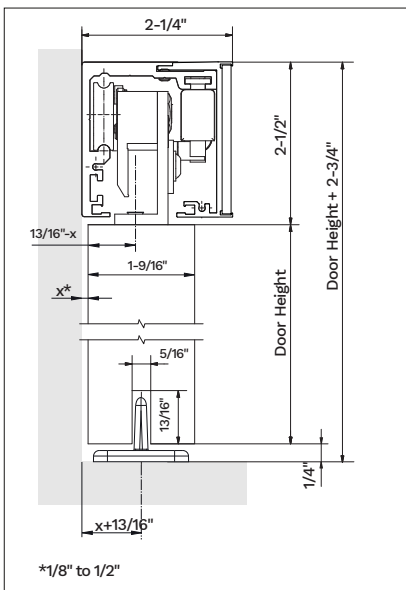

Vertical section with integrated ceiling rail

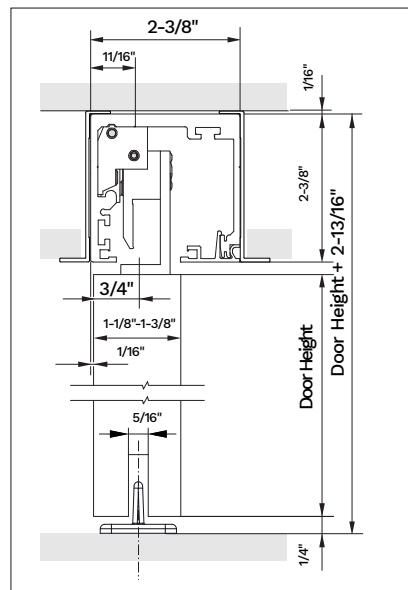

Product Description

BARTELS Box Track

Sliding Set for Wood Doors

Calculation of Door Widths

(Please note the minimum widths according to the product description - 1" overlap is recommended)

One-Panel

- **DoorWidth** = Wallopening dimension + 1-15/16"
- **TrackLength** = min. wallopening dimension x 2

Front View (Scheme)

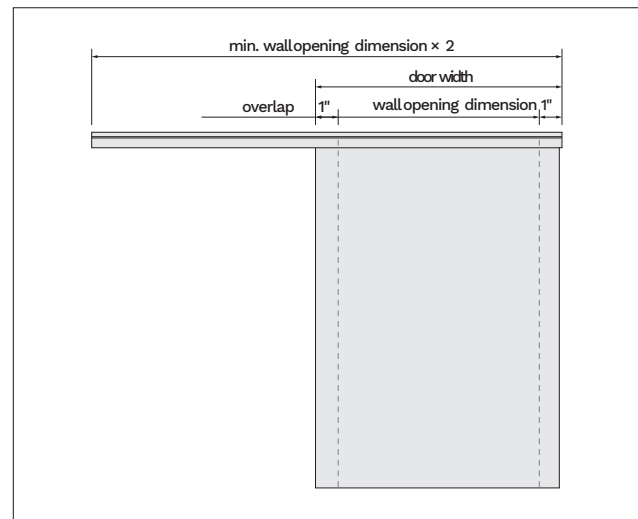

Two-Panel:

- **Door Width** = Wallopening dimension / 2 + 1" per panel
- **Length of the running rail** = min. wallopening dimension x 4

